

YAPI ve DİLATASYON PROFİLLERİ

CONSTRUCTION & TOP FINISHING COVER PROFILES



DEMİRTAŞ METAL
ALÜMİNYUM PROFİL SAN. ve TİC. A.Ş.

NO : 94-1002
0,620 Kg.m.

NO : 94-1003
0,575 Kg.m.

NO : 94-1007
0,710 Kg.m.

NO : 94-1008
0,285 Kg.m.

NO : 94-1009
0,455 Kg.m.

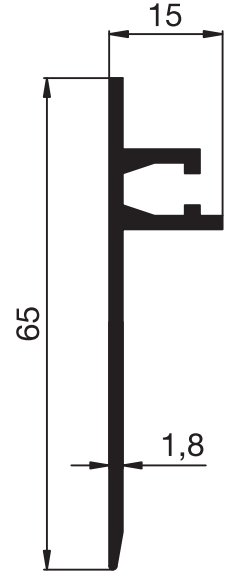
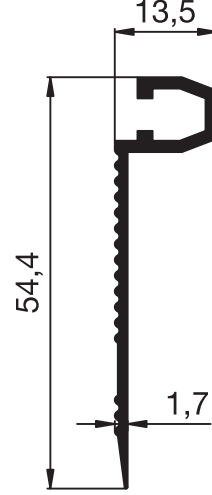
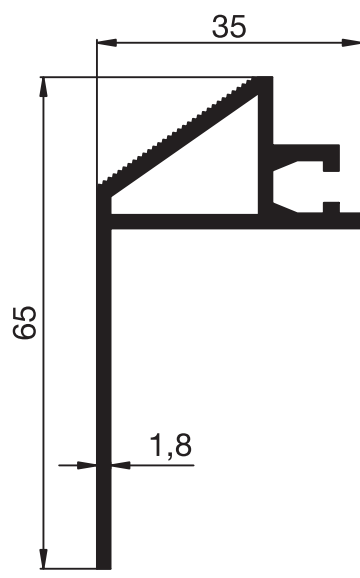
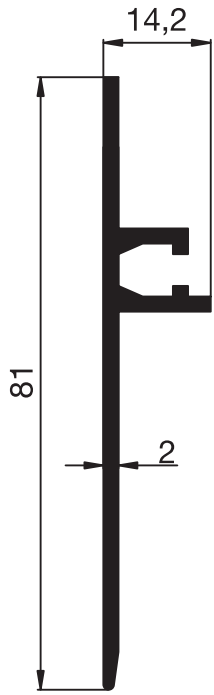
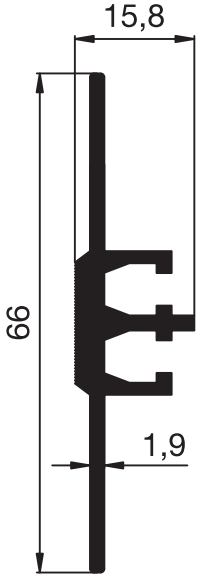

NO : 94-1010
0,395 Kg.m.

NO : 94-1013
0,280 Kg.m.

NO : 94-1014
0,300 Kg.m.

NO : 94-1015
0,290 Kg.m.

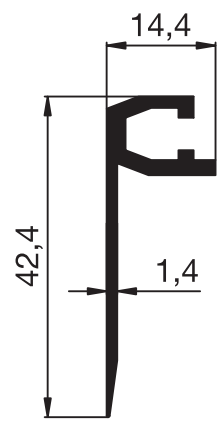
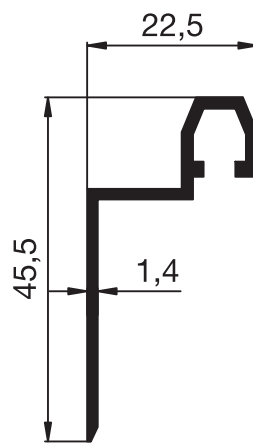
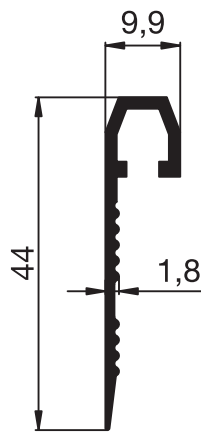
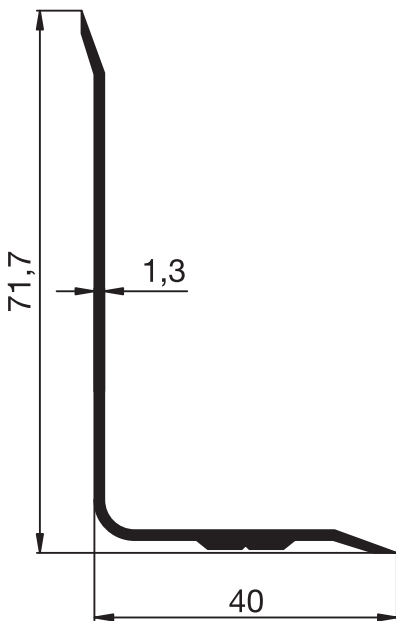



DEMİRTAŞ METAL
ALÜMİNYUM PROFİL SAN. ve TİC. A.Ş.

YAPI ve DİLATASYON PROFİLLERİ

CONSTRUCTION & TOP FINISHING COVER PROFILES

NO : 94-1017
0,260 Kg.m.

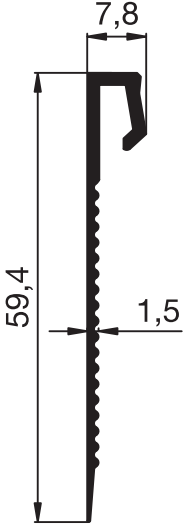

NO : 94-1018
0,720 Kg.m.

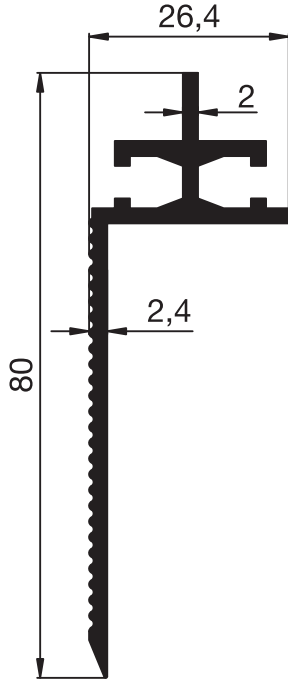

NO : 94-1019
0,340 Kg.m.

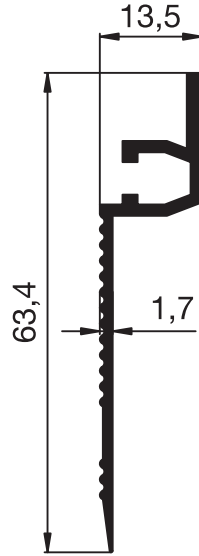

NO : 94-1020
0,430 Kg.m.

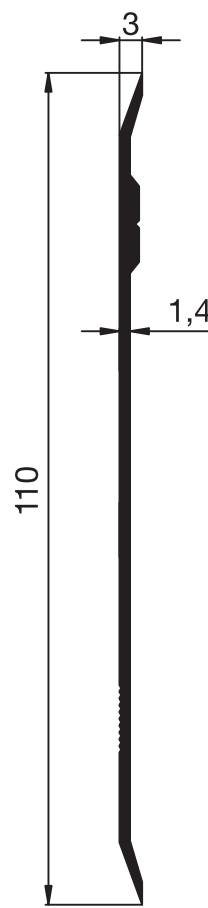

NO : 94-1023
0,690 Kg.m.

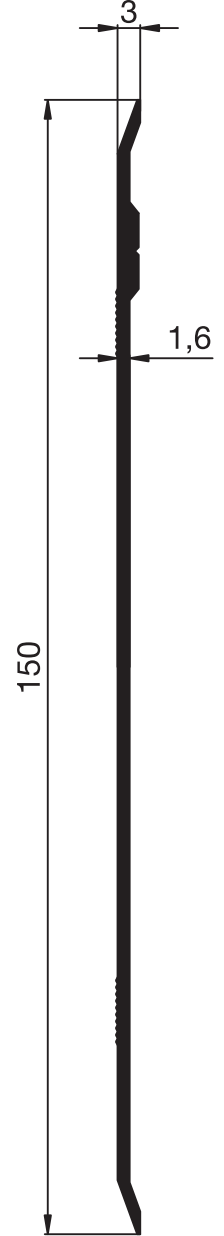

NO : 94-1021
0,255 Kg.m.

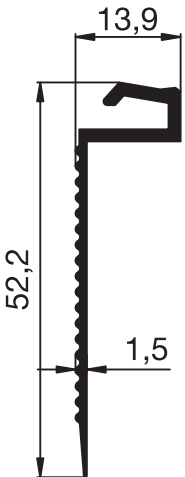

NO : 94-1025
1,310 Kg.m.

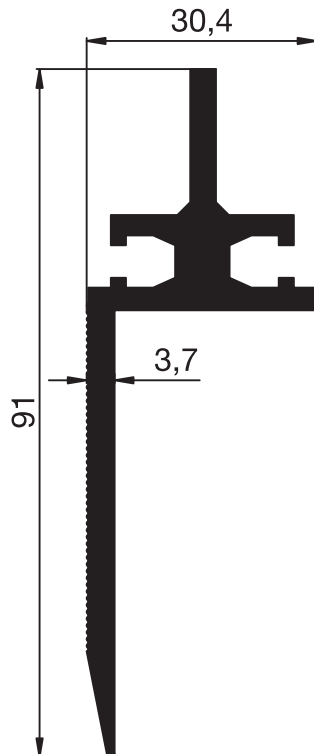

NO : 94-2455
0,130 Kg.m.

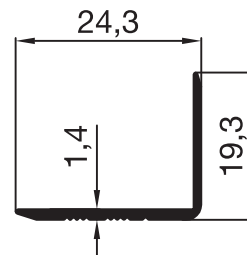

YAPI ve DİLATASYON PROFİLLERİ

CONSTRUCTION & TOP FINISHING COVER PROFILES



DEMİRTAŞ METAL
ALÜMİNYUM PROFİL SAN. ve TİC. A.Ş.

NO : 94-1028
0,160 Kg.m.

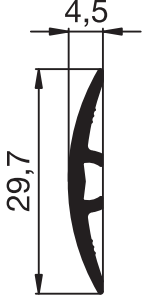

NO : 94-1029
0,230 Kg.m.

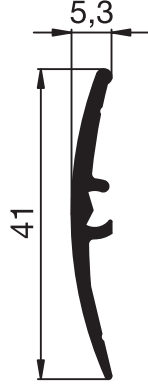

NO : 94-1027
0,170 Kg.m.

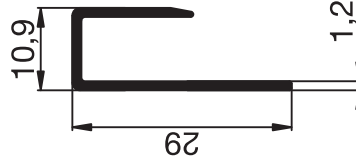

NO : 94-2456
0,160 Kg.m.

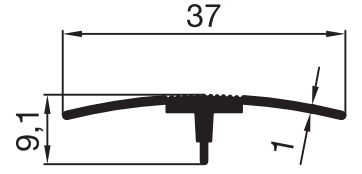

NO : 94-1038
1,140 Kg.m.

NO : 94-1039
0,760 Kg.m.

NO : 94-2285
0,110 Kg.m.

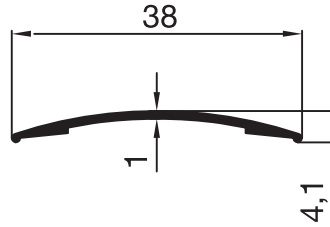

NO : 94-690
0,175 Kg.m.

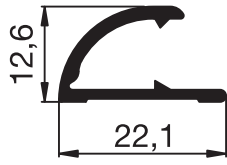

NO : 94-2096
0,430 Kg.m.



NO : 94-2097
0,340 Kg.m.

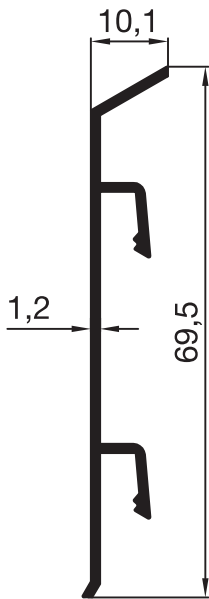

NO : 94-2106
0,295 Kg.m.

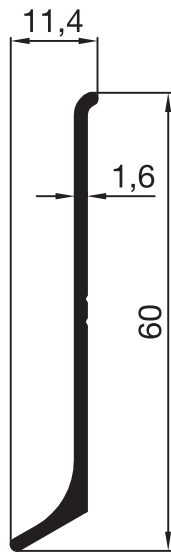

NO : 94-1946
0,355 Kg.m.

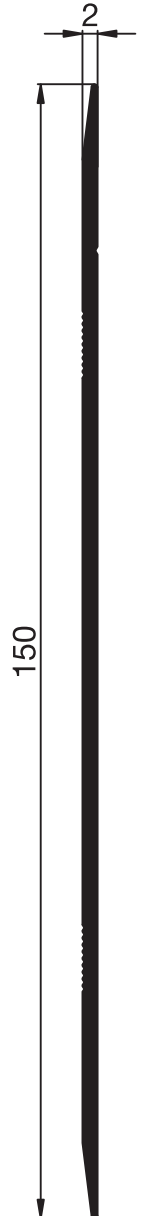
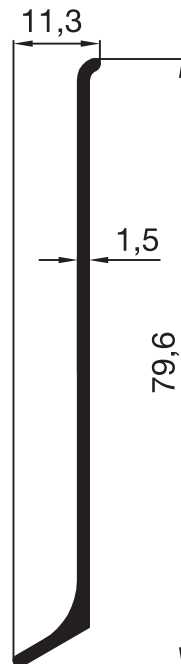

5: 1/1

www.demirtasmetal.com

Profil ağırlıklarımız teorik olup, teslim anındaki tartım değerleri geçerlidir.
Weighting values are valid at the time of delivery, since the weights of the profiles are theoretical.

